

# Data Sheet



Article number: 021300705015

Description: Sealing Clamp S 15 W5

## Measures

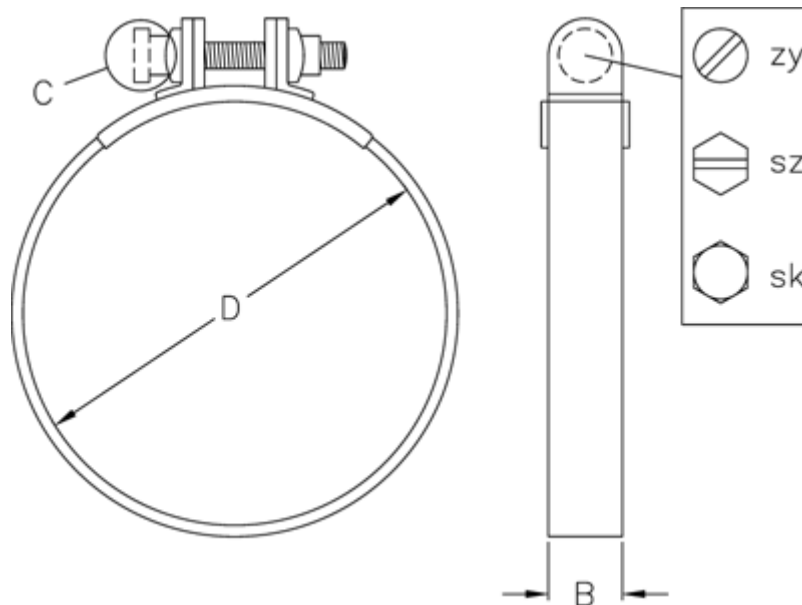

C (screw type) = SZ

Diameter D = 15

Width B = 12